



SD SERIES

MACHINE STANDS



SD Series
02/21/19
Item # 13025

Item #: _____
 Project: _____
 Qty: _____
 AIA#: _____



SD-200 Stand
Shown with a
DM-200B



SD-270 Stand
Shown with a
DCM-270BAH-OS



SD-500 Stand
Shown with a
DCM-500BAH-OS



SD-750 Stand
Shown with a
DCM-751BAH-OS

Features

- ▶ Heavy duty stands for floor model icemakers/dispensers
- ▶ Corrosion resistant stainless steel exterior
- ▶ Easy cleaning with attractive appearance

- Locking doors standard



Warranty:

5 Year Parts & Labor.
Valid in United States, Canada, Puerto Rico and U.S. Territories. Contact factory for warranty in other countries.

Model Number	Use with Cubelet Ice maker/Dispenser	Exterior Dimensions W* x D* x H (height including legs)	Shipping Weight
SD-200	DM-200B	30 x 32 x 32 ^{13/16}	125 lbs.
SD-270	DCM-270BAH, DCM270BAH-OS	16 ^{1/2} x 24 x 35 ^{3/16}	95 lbs.
SD-500	DCM-300BAH, DCM-300BAH-OS, DCM-500B_H, DCM-500B_H-OS	25 ^{7/8} x 22 x 32 ^{3/4}	100 lbs.
SD-750	DCM-751B_H, DCM-751B_H-OS	34 x 28 x 32 ^{3/4}	125 lbs.

*Width and depth measurements are for stands and do not include the flanged legs. Add approximately 1".

Hoshizaki reserves the right to change specifications without notice.



SD SERIES

MACHINE STANDS



SD Series
02/21/19
Item # 13025

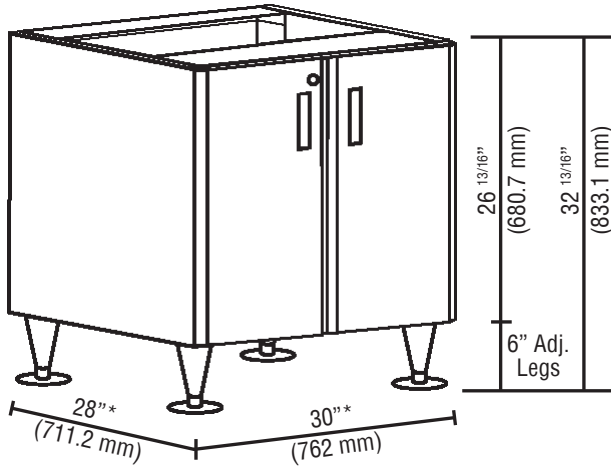

SD-200

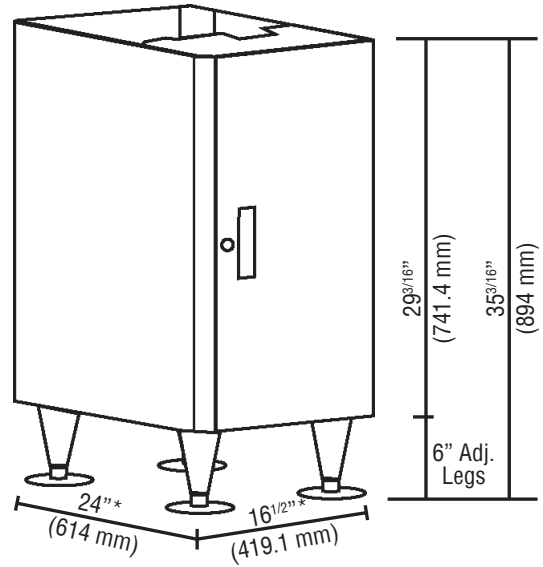

SD-270

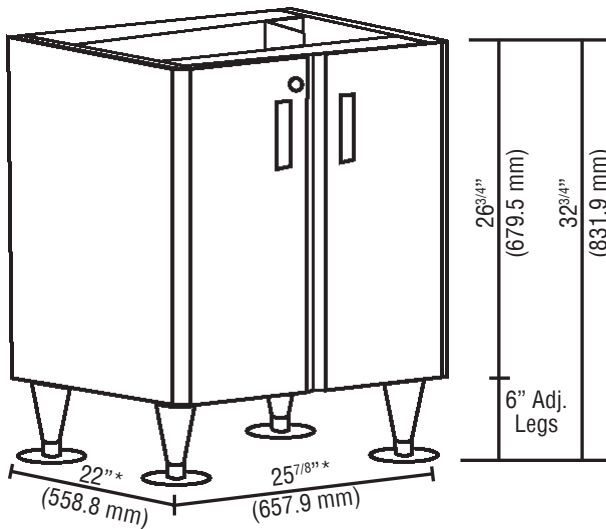

SD-500

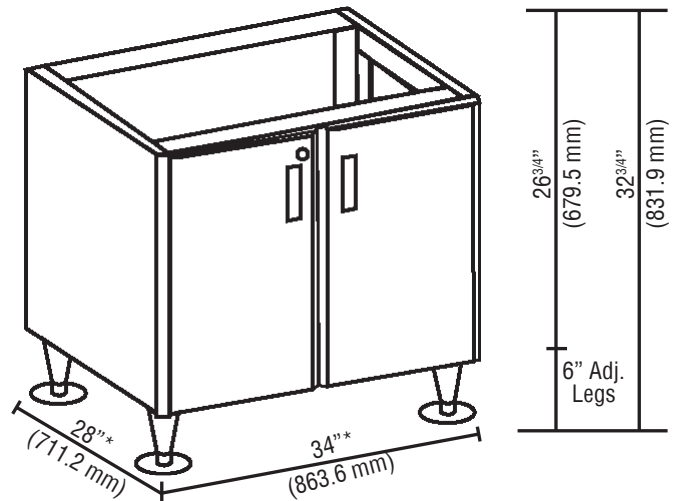

SD-750

*Width and depth measurements are for stands and do not include the flanged legs. Add approximately 1".